

Schnitt A - A

Ansicht

Blick in die Schalung

Seitenansicht von links

Schnitt B - B

Detail Bewehrung Transportanker

Stabliste - Biegeformen

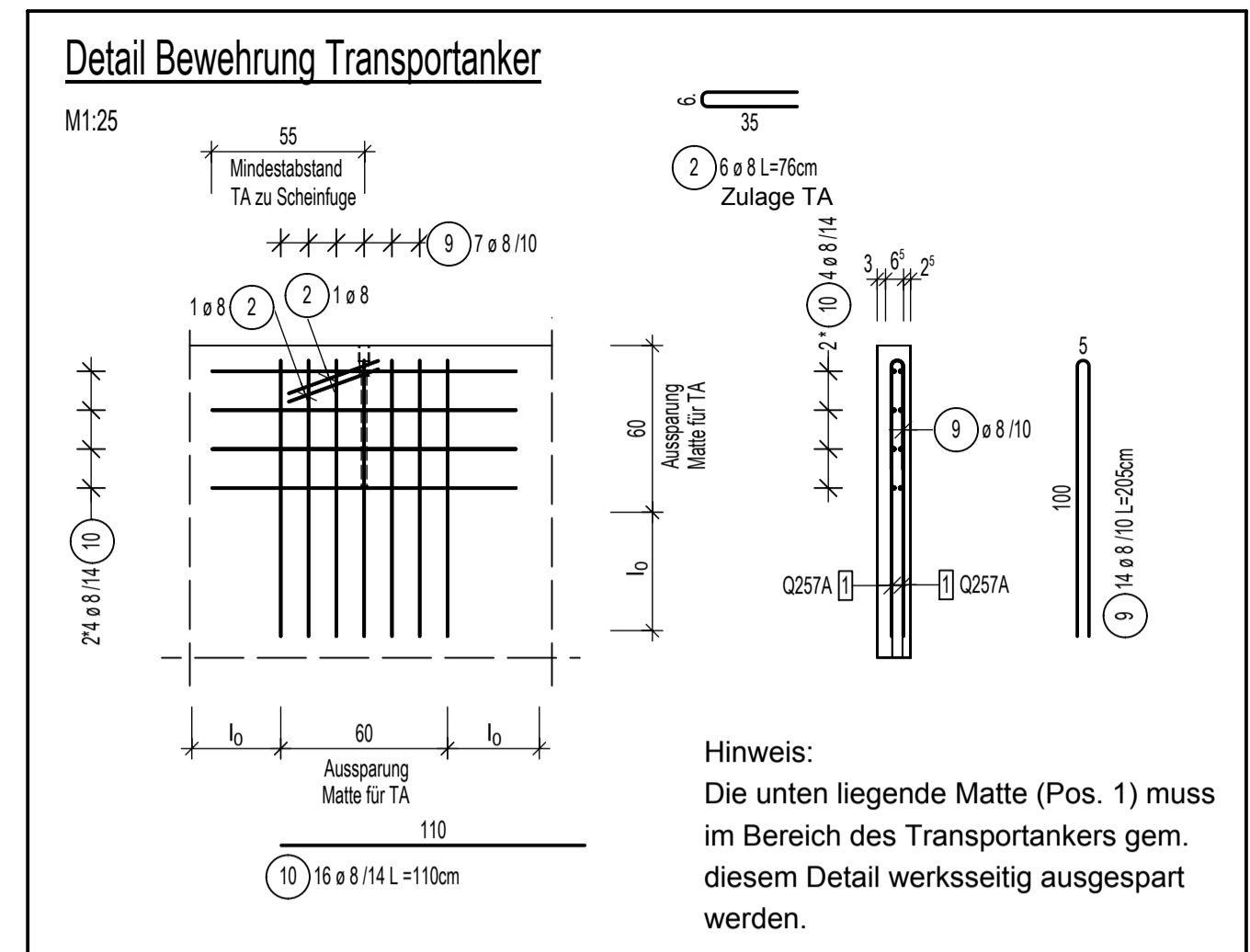
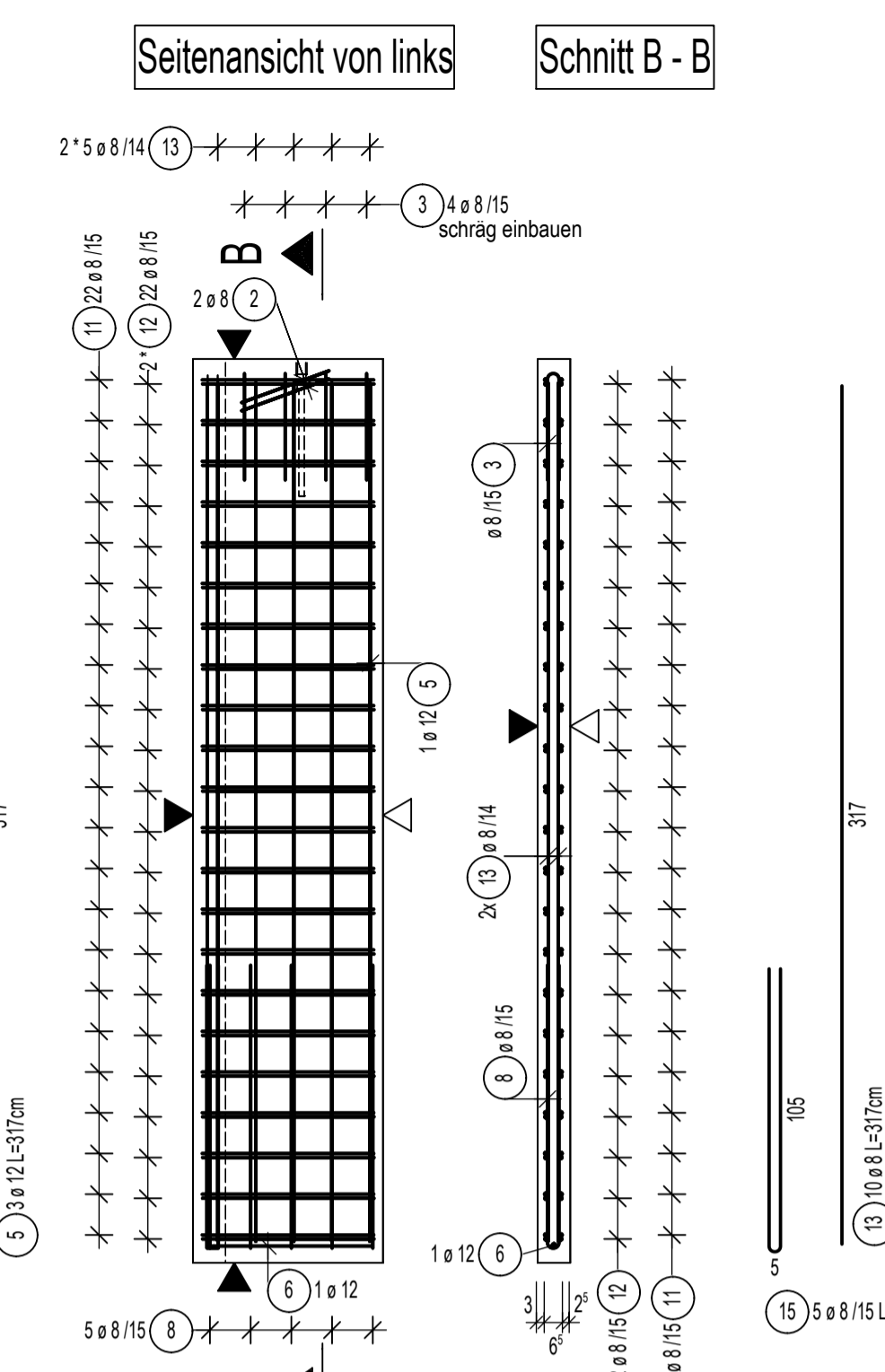
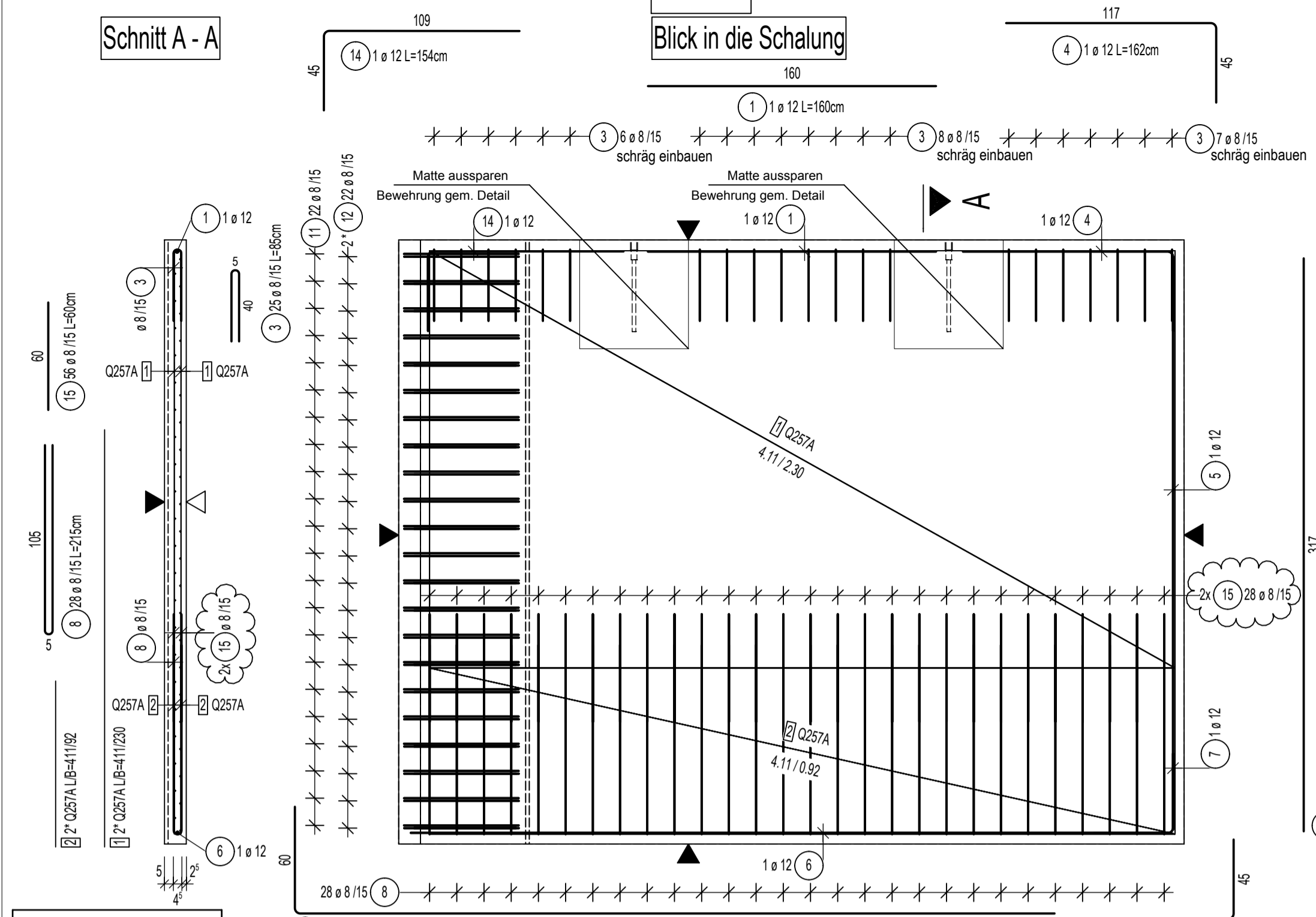

Pos.	Stck	ø [mm]	Einzel Länge [m]	Bemaßte Biegeform (unmaßstäblich)	Gesamt Länge [m]	Masse [kg]
1	1	12	1.60		1.60	1.42
2	6	8	0.76		4.56	1.80
3	25	8	0.85		21.25	8.39
4	1	12	1.62		1.62	1.44
5	3	12	3.17		9.51	8.44
6	1	12	4.80		4.80	4.26
7	1	12	0.90		0.90	0.80
8	33	8	2.15		70.95	28.03
9	14	8	2.05		28.70	11.34
10	16	8	1.10		17.60	6.95
11	22	8	1.87		41.14	16.25
12	44	8	1.21		53.24	21.03

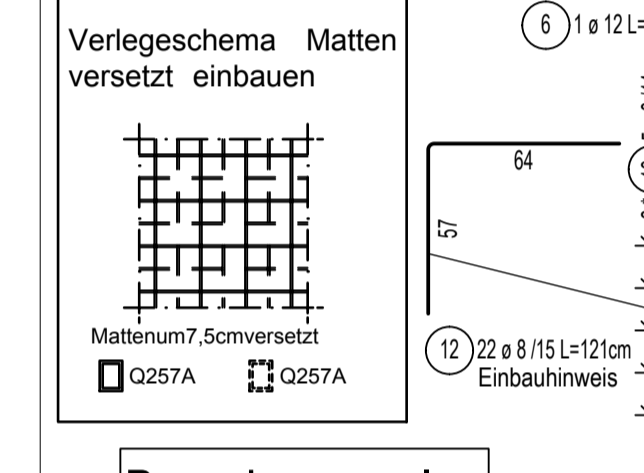

Draufsicht oben

Mattenstahlliste

Pos.	Stück	Mattenbez.	Länge [m]	Breite [m]	Gewicht [kg]
1	2	Q257A	4.110	2.300	77.82
2	2	Q257A	4.110	0.920	30.96

Gesamtgewicht [kg]: 108.78

Stabliste - Biegeformen

Pos.	Stck	ø [mm]	Einzel Länge [m]	Bemaßte Biegeform (unmaßstäblich)	Gesamt Länge [m]	Masse [kg]
13	10	8	3.17		31.70	12.52
14	1	12	1.54		1.54	1.37
15	56	8	0.60		33.60	13.27

Gesamtmasse [kg]: 137.31

Bewehrungsplan

Schalplan

Blick in die Schalung

Seitenansicht von links

Schnitt

3D - Darstellung

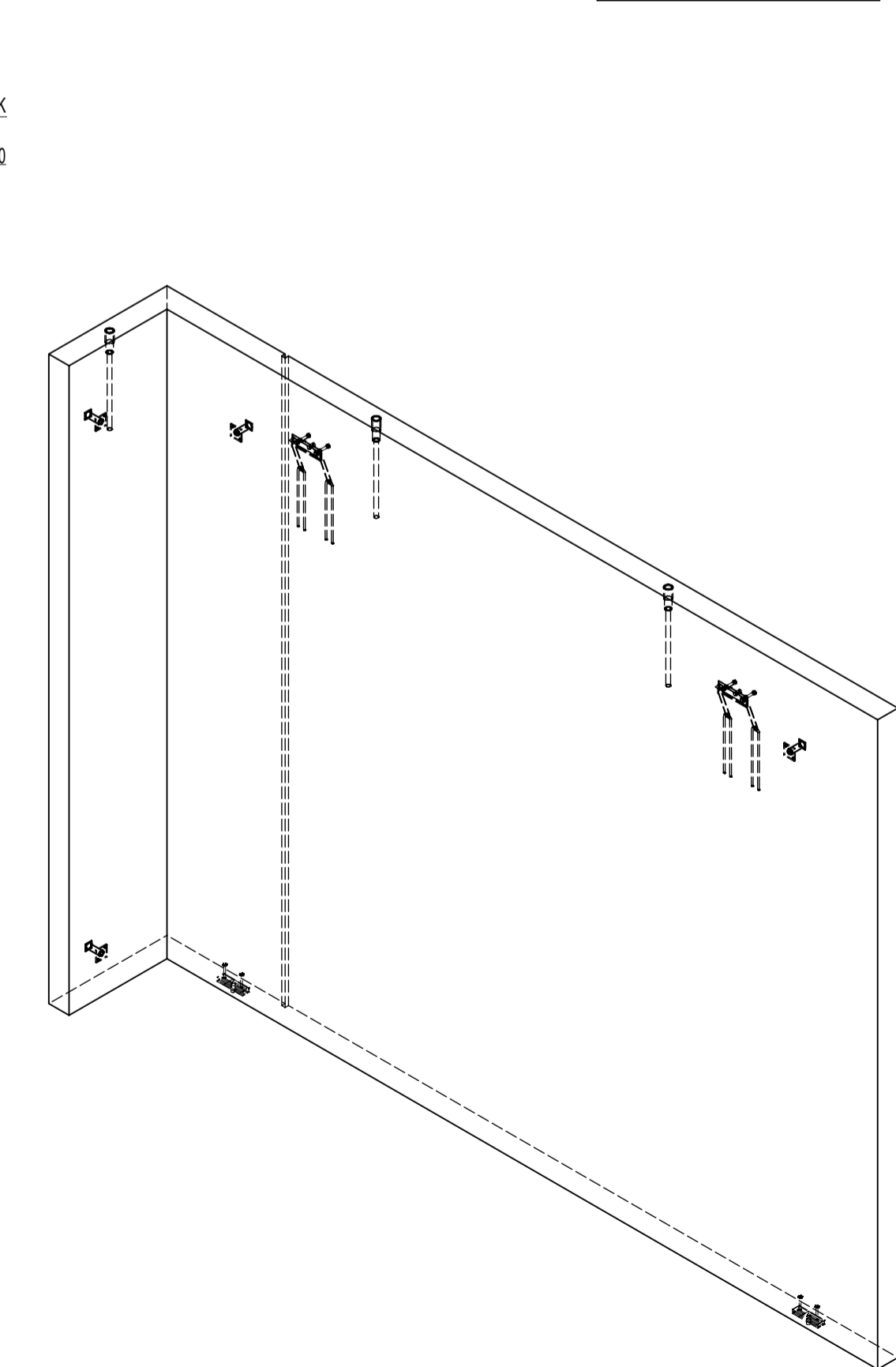
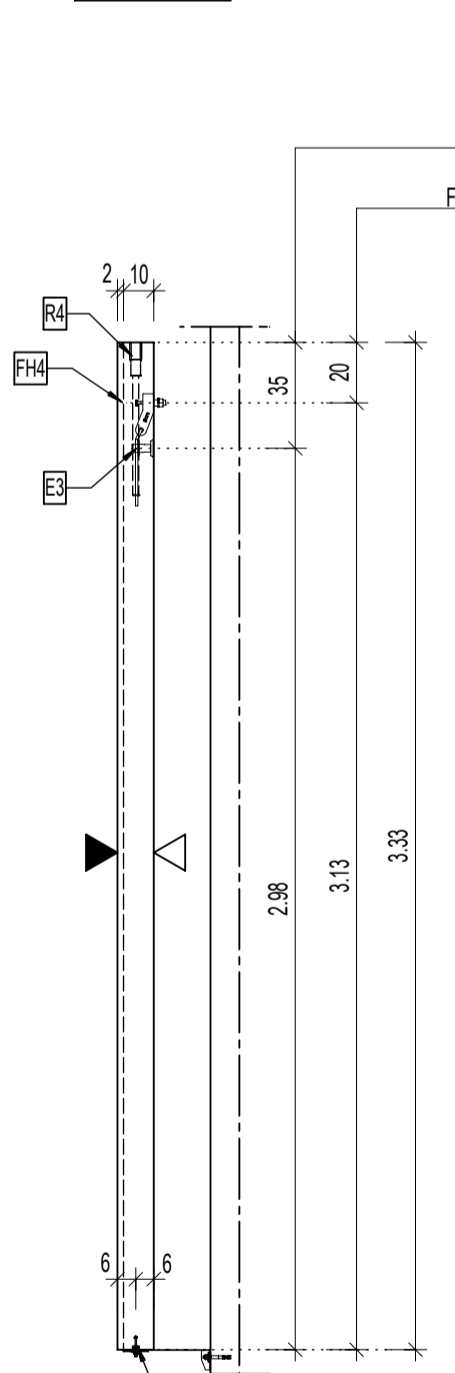
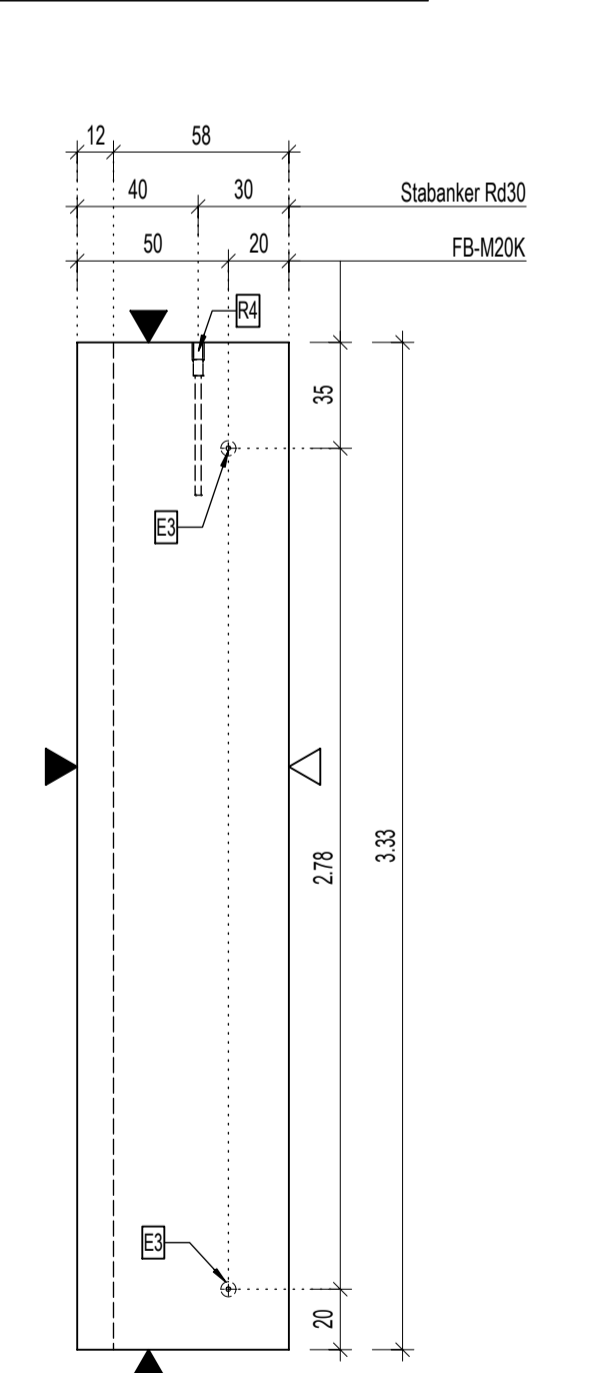
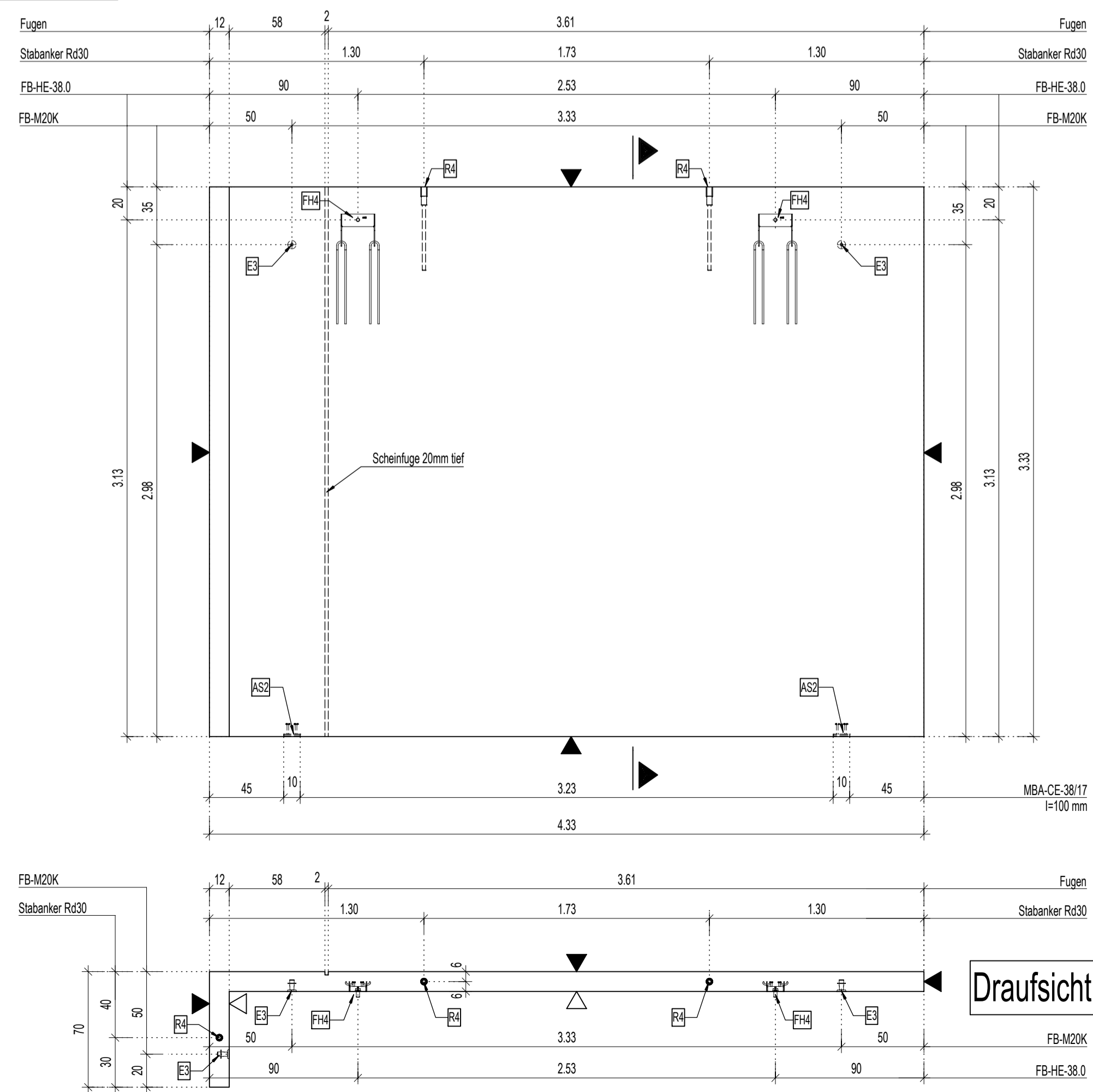

Draufsicht oben